



# FLOTAC®

Veterinary Parasitology and Parasitic Diseases  
Department of Pathology and Animal Health  
Faculty of Veterinary Medicine, University of Naples Federico II  
Via della Veterinaria, 1 - 80137 Naples, Italy  
[www.flotac.unina.it](http://www.flotac.unina.it) - [www.parassitologia.unina.it](http://www.parassitologia.unina.it)

The FLOTAC Manual is divided into two parts:

The first part describes (a) basic principles; (b) components; (c) accessories; (d) assembly; and (e) positions and steps of the FLOTAC®.

The second part describes the Flotac techniques, i.e., new multivalent, copromicroscopic [χοπρος: copros = faeces] techniques which use the FLOTAC®. These techniques are based upon the centrifugal flotation of the sample and the subsequent translation of the apical portion of the floating suspension, and can give parasitic element counts directly in faecal aliquot quantities of 0.5 - 1 grams or more.

Flotation solutions (FS) play a fundamental role in determining the sensitivity, precision and accuracy of any copromicroscopic technique (qualitative and/or quantitative) based upon flotation. The key role of FS is further discussed in the Flotac faecal egg count calibration section of this Manual.

Flotac techniques augment the efficiency of the various FS regarding the flotation of large numbers of parasitic elements, but they can also augment the negative aspects of some FS regarding the turbidity of readings, and the flotation of small and large faecal debris. As a consequence, not all the FS used in parasitological labs can be used with the Flotac techniques. The Flotation Solutions section of this Manual reports the chemical composition of the 9 FS that give the best results using the Flotac techniques with respect to the clarity of readings, sensitivity, precision and accuracy.

The Appendix: Flotation Solutions and Parasitic Elements (in a separate booklet), reports the schemes that show the most efficient FS for the most common parasitic elements eliminated with faeces from different herbivorous species.

The Flotac techniques are designed for use by researchers, and all laboratory technicians who need highly accurate and precise results, where such results are more important than the simplicity or cost of the technique chosen.

It is our fond hope that the use of the Flotac techniques will help the advancement of knowledge in the fields of human and veterinary parasitology.

## FLOTAC 100

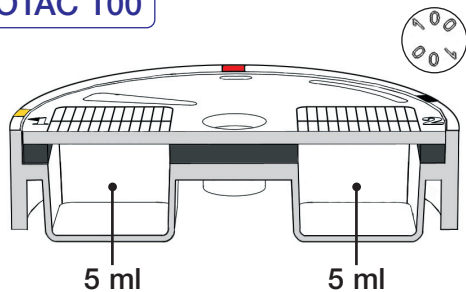

## FLOTAC 400

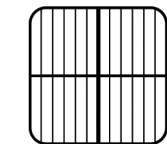
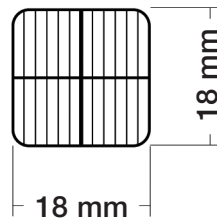
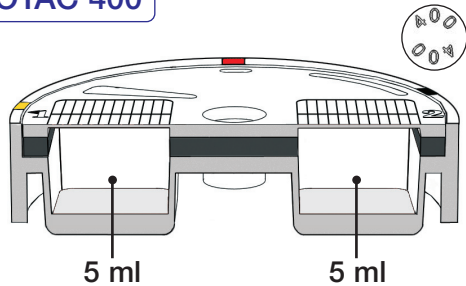

12 sections

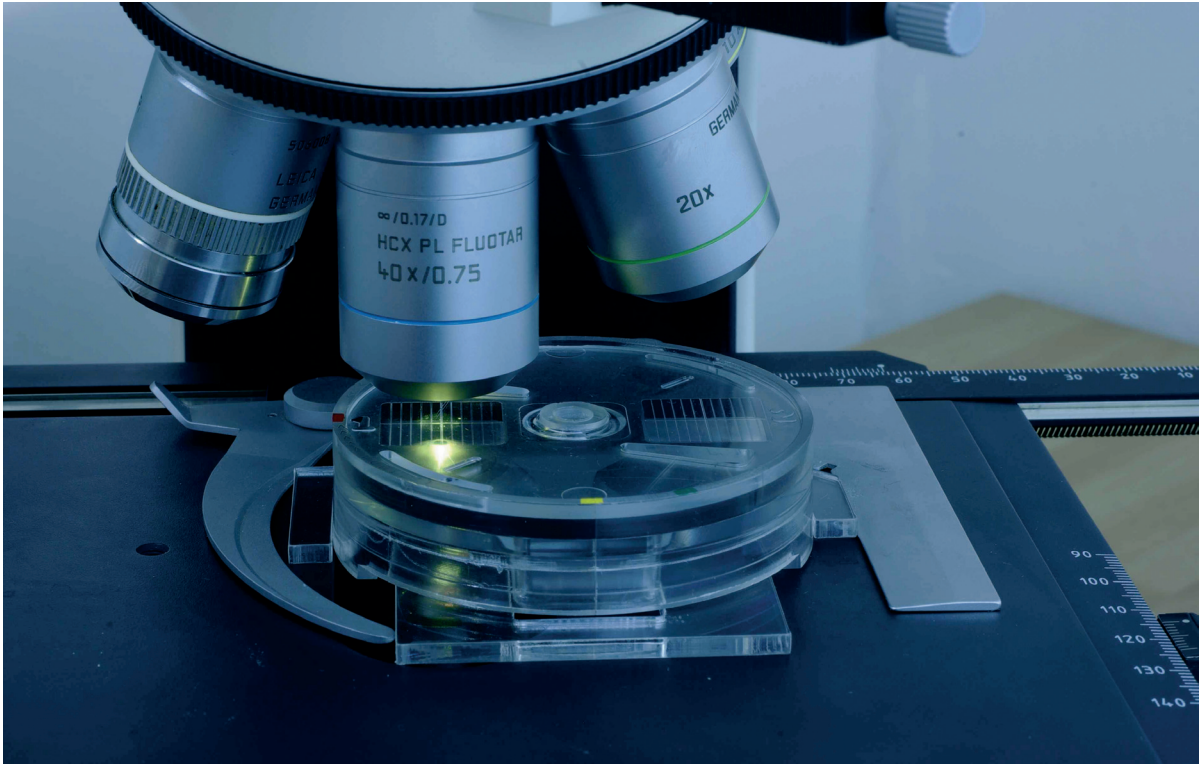

**1<sup>st</sup> Part - FLOTAC<sup>®</sup> technical aspects and functioning**

Basic principles .....	p. 11
Components .....	p. 14
Accessories .....	p. 20
Assembly .....	p. 25
Operating steps .....	p. 31

**2<sup>nd</sup> Part - Flotac techniques**

Introduction .....	p. 41
Faecal sampling .....	p. 45
Flotac basic technique .....	p. 49
Flotac dual technique .....	p. 53
Flotac double technique .....	p. 57
Fat faeces .....	p. 61
Faecal sample dilution .....	p. 64
Flotac faecal egg count calibration .....	p. 67
Flotation solutions .....	p. 75

**IN ORDER TO SAVE TIME AND COST, PLEASE READ  
THIS MANUAL BEFORE USING THE FLOTAC®**

The following laboratory equipment is required for the Flotac techniques:

1. FLOTAC 100 and/or FLOTAC 400
2. Centrifuge: large volume centrifuge (with buckets of at least 75 mm diameter) or benchtop centrifuge with rotor for microtitre plates
3. Microscope: conventional optical microscope with a travel range of at least 25 mm (FLOTAC® is 19 mm high)

**1<sup>st</sup> Part**

**FLOTAC<sup>®</sup>**

**Technical aspects and  
functioning**

# Checking Supplied FLOTAC® Components and Accessories

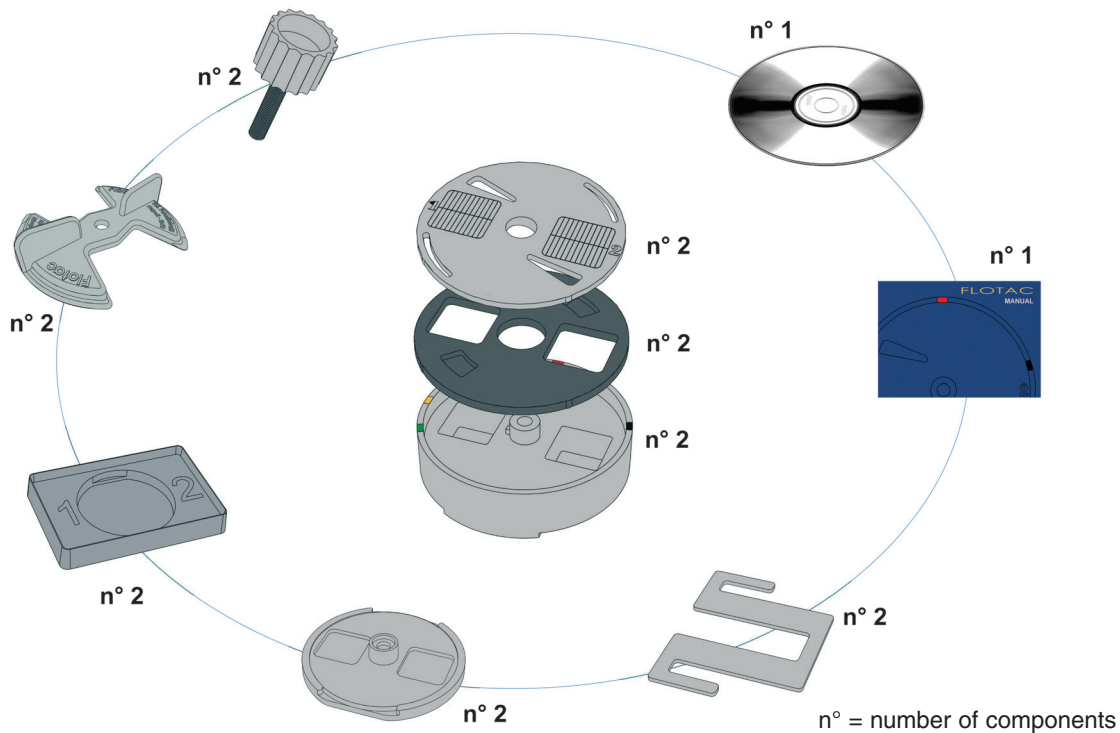



Traditional tube flotation methods use a coverslip which is removed from the top of the faecal suspension tube and then placed on a microscope slide.

Potential problems with this method include:

- not all of the parasitic elements (cysts, oocysts, eggs and larvae) float to the top of the suspension;
- not all of the floated parasitic elements adhere to the underside of the coverslip.

However:

- when flotation takes place in a centrifuge, all parasitic elements float to the top;
- if the top portion of the flotation suspension is cut transversally (i.e. translated), all parasitic elements can be collected and observed under the microscope.

FLOTAC® was developed in order to:

- carry out the flotation in a centrifuge;
- cut the top portion of the flotation suspension transversally (i.e. translation);
- examine the entire translated suspension under the microscope.

### Traditional tube flotation

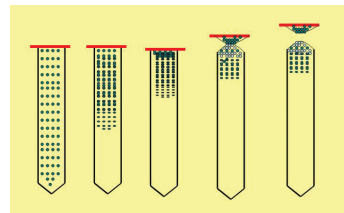

### Flotac techniques

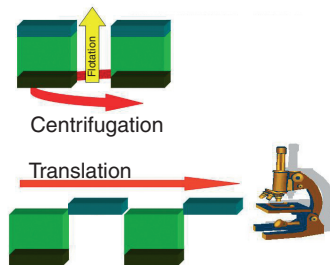

### Base

Upper side

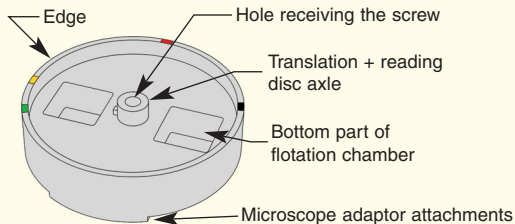

Lower side

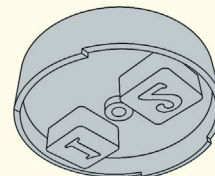

### Translation disc

Upper side

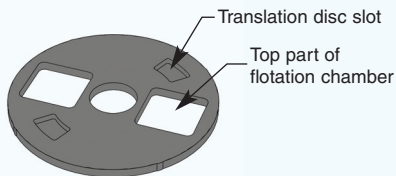

Lower side

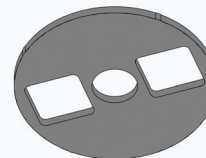

### Reading disc

Upper side

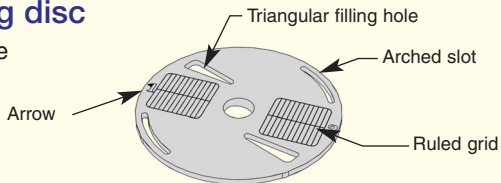

Lower side

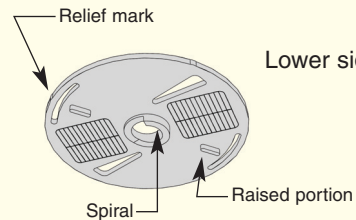

**Bottom**

Upper side

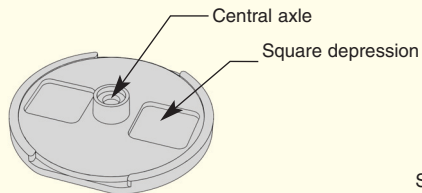

Lower side

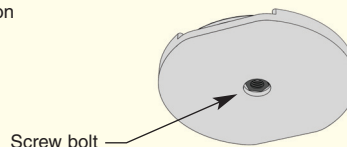

**Key**

Upper side

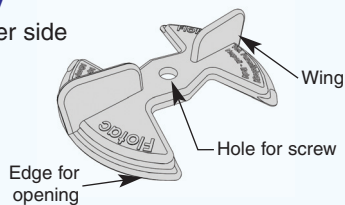

Lower side

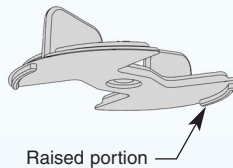

**Screw**



**Centrifuge adaptor**

Upper side

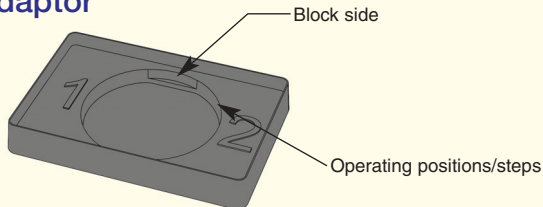

**Microscope adaptor**

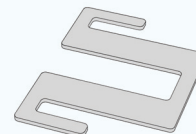

The two bottom parts of the flotation chambers in the **Base** have upward and outward directed trapezoidal walls whose low frictional resistance allows for better flotation of the parasitic elements.

The chambers are labelled 1 and 2, respectively; these numbers are printed in transparent relief on the outer side of the **Base**.

The translation + reading disc axle at the centre of the **Base** has a hole designed to receive the **Screw**. The protuberance on the axle is asymmetrical because it both serves to stop the two FLOTAC® discs at the end of the translation step, and allows these discs to slide freely until the FLOTAC® apparatus is opened.

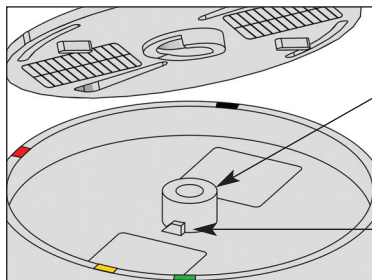
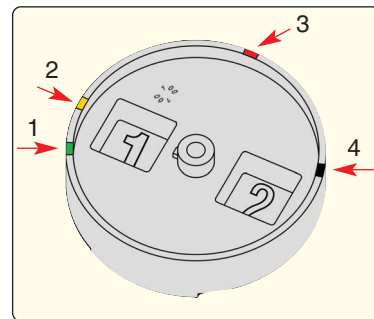

Translation + reading discs axle

Protuberance

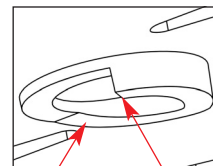

Slide and open mechanisms

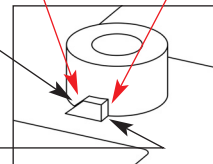

Disc stop

The upper **Base** wall holds the **Translation disc** and the **Reading disc**. It also has four notches at 90° from each other which function together with the four relief marks on the **Translation disc** and the two relief marks on the **Reading disc**. These notches and relief marks serve to check and control the disc movements.

The edge of the upper **Base** wall is inscribed with four words and four numbers that are marked with four colours that name the four FLOTAC® operating positions:

FILLING (n. 1 - green), CLOSED (n. 2 - yellow), READING (n. 3 - red), and OPEN (n. 4 - black).

The edge of the lower **Base** wall has two raised sections which are the **Microscope adaptor** attachments that serve to secure the FLOTAC® apparatus to the **Microscope adaptor** under the microscope.

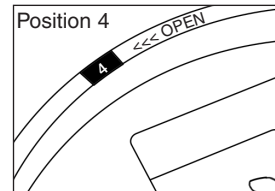
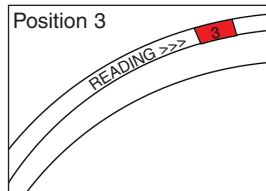
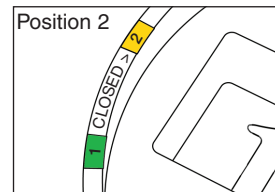
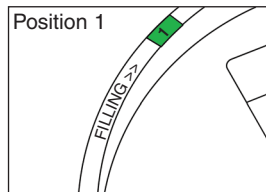
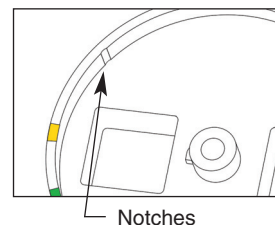
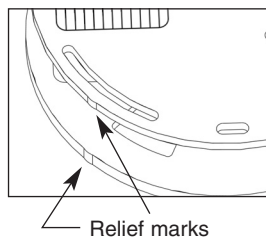
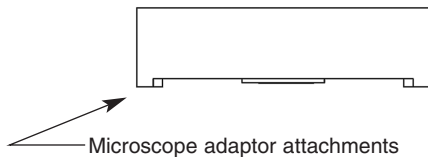

There are two versions of the **Base**: (a) **Base 100X**, which is used together with the **Reading disc 100X**; and (b) **Base 400X**, which is used together with the **Reading disc 400X**. The only difference between the two Bases is the thickness of the bottom of the flotation chambers: the **Base 400X** has a thicker bottom than the **Base 100X**.

The **Translation disc** has a central hole, which fits on the translation + reading disc axle, and two square openings which form the tops of the two flotation chambers.

The upper side of the disc has two **Translation disc slots** which receive the two raised portions on the lower side of the **Reading disc**. These mechanisms are operative in the translation step.

The circumference edge of the **Translation disc** has four relief marks at 90° from each other which correspond to the four notches on the upper **Base** wall.

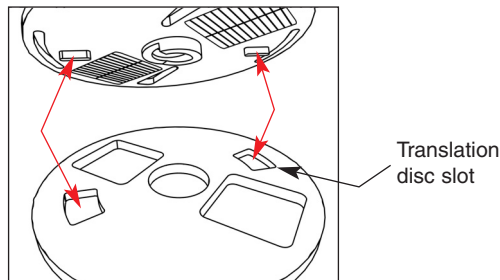
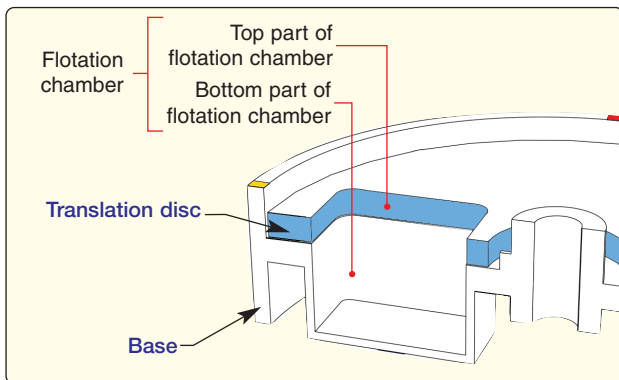
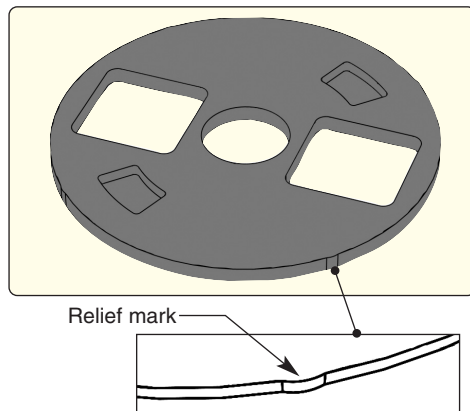

The lower side of the **Reading disc** is engraved with two ruled grids. This side also has two raised portions which are operative in the translation step, and an ascending spiral around the central hole that both serves to stop the translation step, and to open the FLOTAC® apparatus.

The circumference of the disc has two relief marks which are spring actuated to work together with the four notches on the upper **Base** wall.

The two arched slots on the **Reading disc** receive the two raised portions of the **Key**.

The two flotation chambers are filled through the two triangular filling holes on the **Reading disc**.

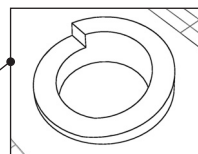
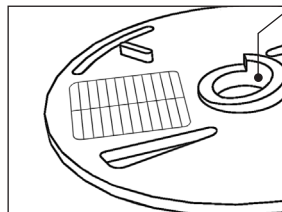
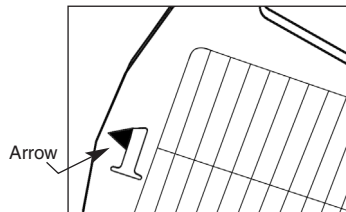
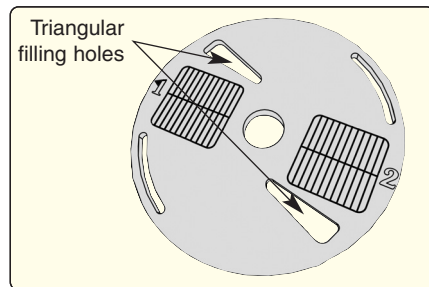

Ascending spiral

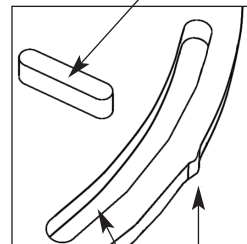

Arched slot

Relief mark

Each ruled grid is 18 x 18 mm and is divided into 12 parallel sections by means of transparent lines printed in relief.

In addition, each ruled grid is divided into four quadrants by two thick intersecting lines.

The two ruled grids are labelled 1 and 2, respectively, with their numbers transparently printed in relief on the upper side of the **Reading disc**.

It is important to note that the upper portion of the number 1, called **Arrow**, serves to indicate the positions of the four FLOTAC® operating positions used in the FLOTAC® operating steps.

There are two versions of the **Reading disc**:

- (a) **Reading disc 100X**, which permits a maximum magnification of 100X;
- (b) **Reading disc 400X**, which permits a maximum magnification of 400X.

The only difference between the two discs is the fineness of the ruled grid, which is finer in the **Reading disc 400X**.

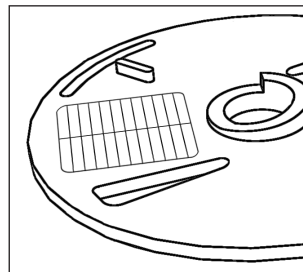

**Reading disc 100X**

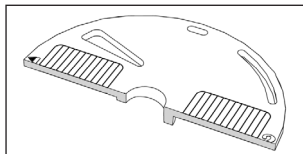

**Reading disc 400X**

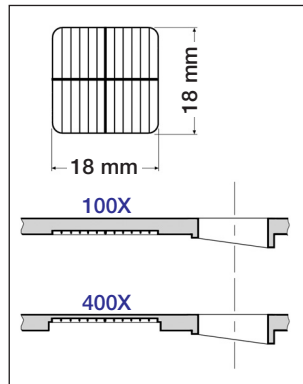
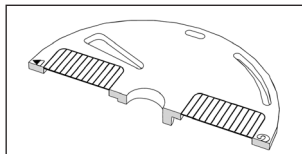



## FLOTAC 100

When FLOTAC® is assembled with the **Reading disc 100X** and with the **Base 100X** it is referred to as **FLOTAC 100**.

It has two flotation chambers which are 5 ml each  
 - total volume = 10 ml

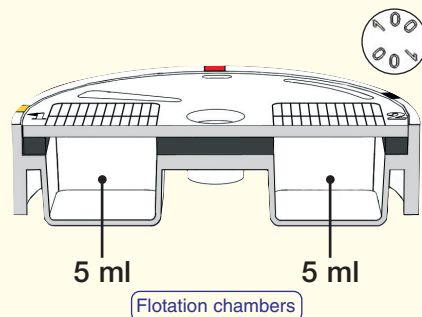

## FLOTAC 400

When FLOTAC® is assembled with the **Reading disc 400X** and with the **Base 400X** it is referred to as **FLOTAC 400**.

It has two flotation chambers which are 5 ml each  
 - total volume = 10 ml

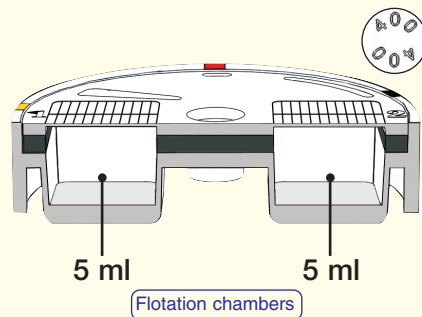

The **Translation disc** and the FLOTAC® accessories can be used both with **FLOTAC 100** and **FLOTAC 400**.

The **Bottom** is relatively thick because it has to sustain the deformation forces arising during centrifugation. The upper side has two square depressions which receive and support the bottoms of the two flotation chambers of the **Base**.

The circumference of the **Bottom** has two parallel sides which serve to lock the FLOTAC® apparatus onto the **Centrifuge adaptor**.

The centre axle of the **Bottom** contains a **Screw bolt** which receives the **Screw** thus guaranteeing that the FLOTAC® apparatus is sealed during centrifugation.

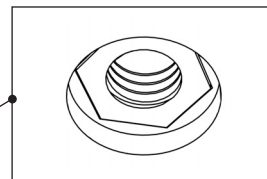
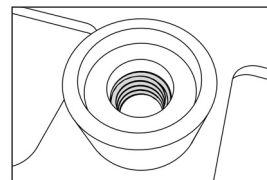
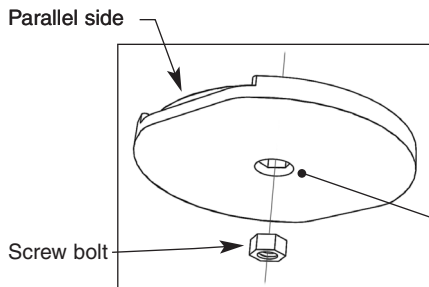
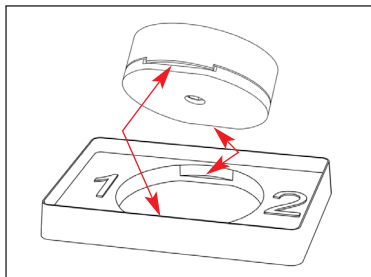
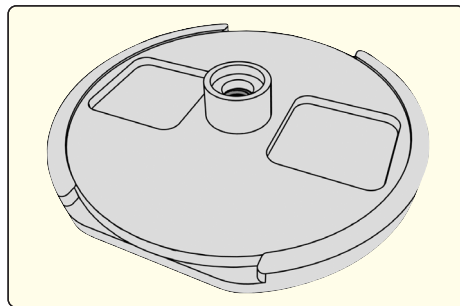

The **Key** has three main functions:

- 1) It seals the FLOTAC® apparatus during centrifugation.
- 2) It activates the four FLOTAC® operating positions (FILLING, CLOSED, READING and OPEN).
- 3) It opens the FLOTAC® apparatus.

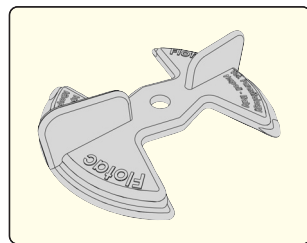
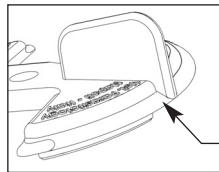

Edge for opening

## SCREW

The **Screw** holds the entire FLOTAC® apparatus tightly together during centrifugation.

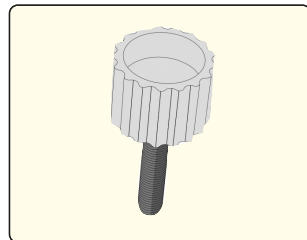

The **Centrifuge adaptor** is rectangular in shape with a circular depression at its center.

The **Centrifuge adaptor** has three main functions:

- 1) It adapts the FLOTAC® apparatus to microtitre centrifuge holders.
- 2) It duplicates, in larger letters, the operating position words found on the edge of the upper **Base** wall.
- 3) Since the FLOTAC® apparatus can be held in this adaptor during all the operating steps, it serves as a collector of any overflow of faecal suspension.

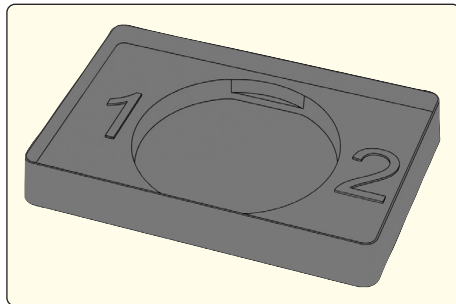

FLOTAC® operating positions/steps

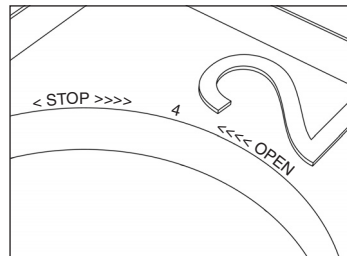
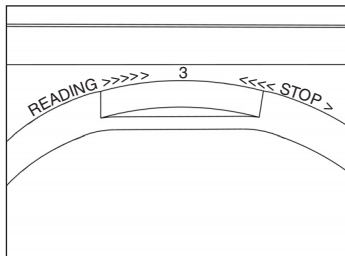
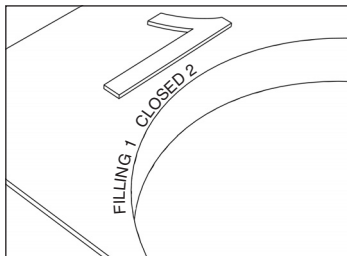

The **Microscope adaptor** maintains the FLOTAC® apparatus securely under the microscope, and it is transparent in colour in order to allow the unhindered passage of the microscope light.

If the **Microscope adaptor** is inconsistent with the microscope translation table, the FLOTAC® can be placed over a microscope slide on the microscope translation table.

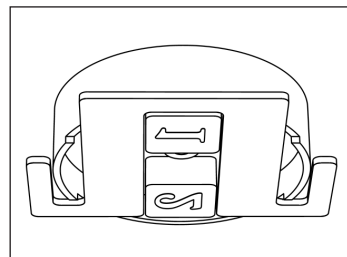
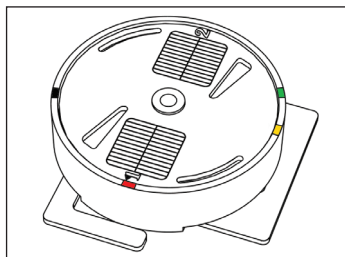
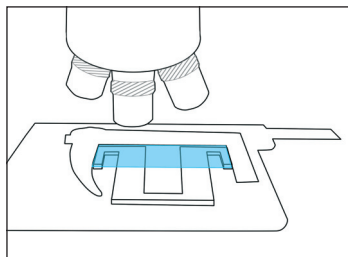
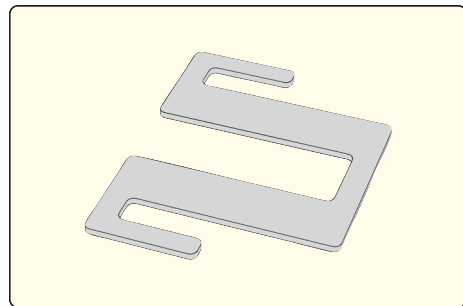

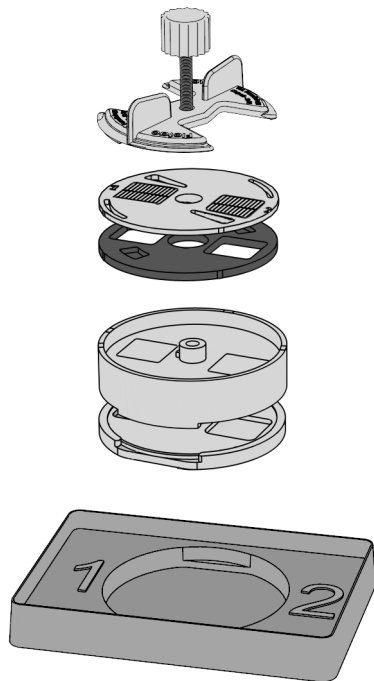

SCREW

KEY

READING DISC

TRANSLATION DISC

BASE

BOTTOM

CENTRIFUGE ADAPTOR

In order to avoid damage to any of the FLOTAC® components during assembly, it is important to adhere to the following instructions:

- 1) Place the **Centrifuge adaptor** on the work table with the number 1 to the left.
- 2) Place the **Bottom** onto the **Centrifuge adaptor**.
- 3) Place the **Base** on the **Bottom** so that the undersides of the two flotation chambers enter into the square depressions of the **Bottom** with chamber 1 on the left.

Number 1 on the left

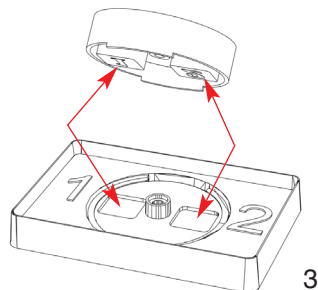
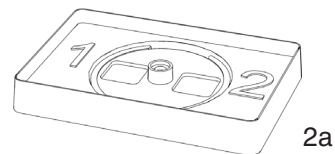
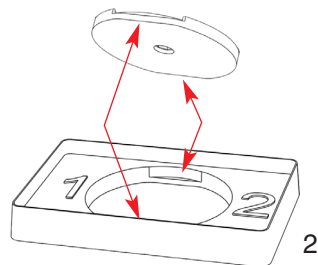
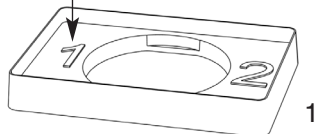

- 4) Place the lower side of the **Reading disc** onto the upper side of the **Translation disc**, so that the two raised portions of the **Reading disc** enter the two **Translation disc** slots.
- 5) Turn only the **Reading disc** counter-clockwise (about 30°) until the raised portions of the **Reading disc** stop further movement.

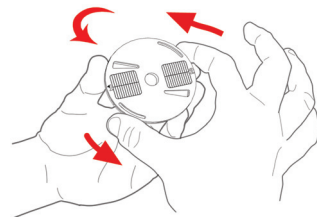
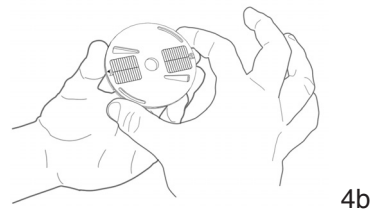
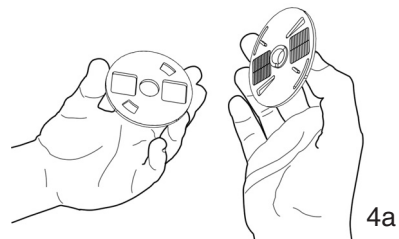
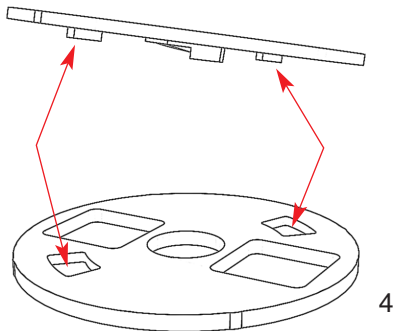

5



- 6) Place the two disc assembly on the **Base** with the number 1 arrow aligned to the n. 1 (green mark) on the **Base** edge.
- 7) Press the assembly to snap it closed. The filling holes and the flotation chambers are now fully aligned.

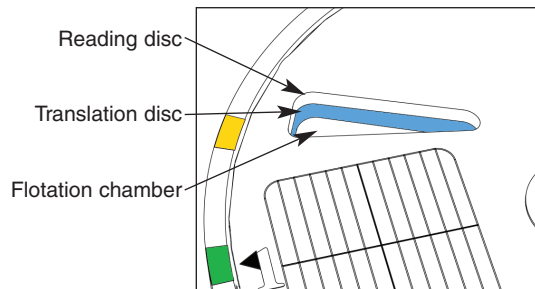
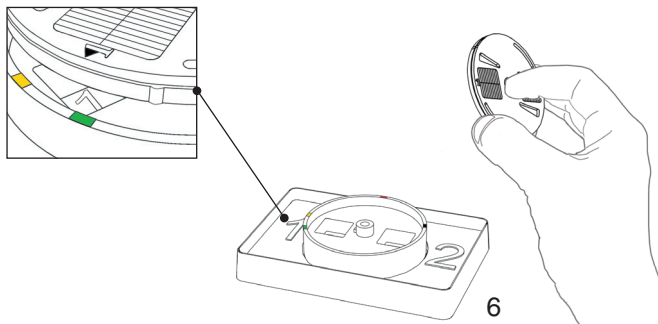

It is advisable to moisten the **Translation disc** with tap water before assembly.

- 8) Place the **Key** on the assembly so that the raised portions on the underside of the **Key** fit into the arched slots on the **Reading disc**.
- 9) Insert the **Screw** into the center of the axle, and tighten until closure is firm. This seals the two discs to the **Base**.
- 10) Now slightly loosen the **Screw** in order to allow the **Key** to rotate.

The FLOTAC® chambers are now ready to be filled.

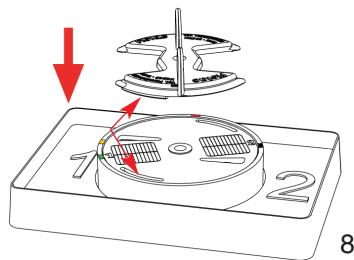

8

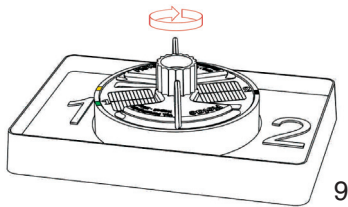

9

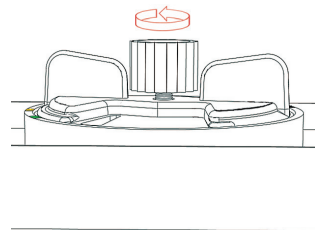

10

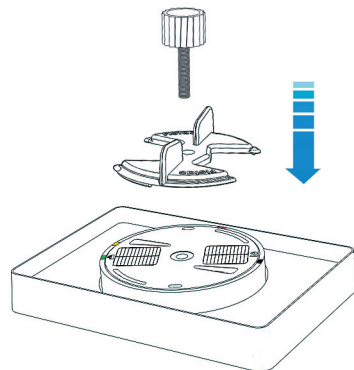

Note - If the chambers are not fully aligned, rotate the two discs on the right (until n. 3 - red mark - on the **Base** edge) and then on the left until the arrow returns at its first position (i.e. until n. 1 - green mark - on the **Base** edge). With this movement, the **Reading disc** trails the **Translation disc** and the chambers will be fully aligned.

1 - FILLING

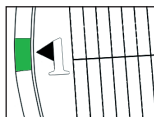

2 - CLOSING

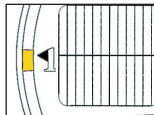

3 - CENTRIFUGATION

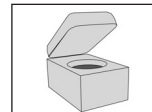

4 - TRANSLATION

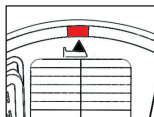

5 - READING

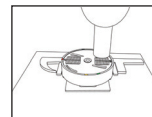

6 - EMPTYING

7 - OPENING

8 - CLEANING

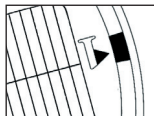

When the **Arrow** is aligned with the number 1 on the **Base** edge (green mark), the filling holes are fully opened, and the flotation chambers can be filled with the faecal suspension using a pipette until a little meniscus is formed.

In order to avoid the formation of air bubbles, chamber 1 must be filled with the FLOTAC® apparatus on the **Centrifuge adaptor** inclined towards the technician (a), and chamber 2 must be filled with the FLOTAC® apparatus on the **Centrifuge adaptor** inclined away from the technician (b).

Note: when using FLOTAC 400, greater inclinations are required.

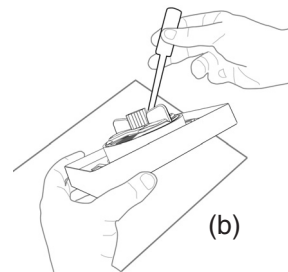
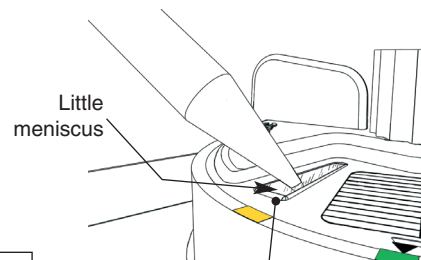
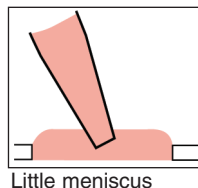
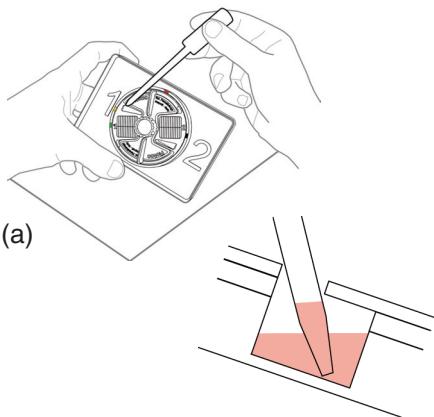
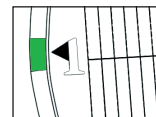

- a) After the chambers are filled, the **Key** is used to turn the **Reading disc** clockwise (about 30°) until the arrow is aligned with the number 2 on the **Base** edge (yellow mark - CLOSED)\*.

The two ruled grids are now super imposed over the two flotation chambers.

- b) Tighten the **Screw**, and aspirate the residual faecal suspension from the filling holes.

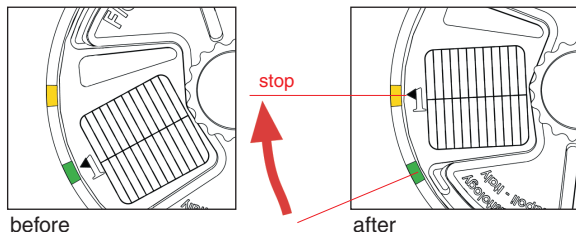

\* In this step, only the **Reading disc** must be rotated. Don't press on the **Key** during the closing. The **Translation disc** must be firm.

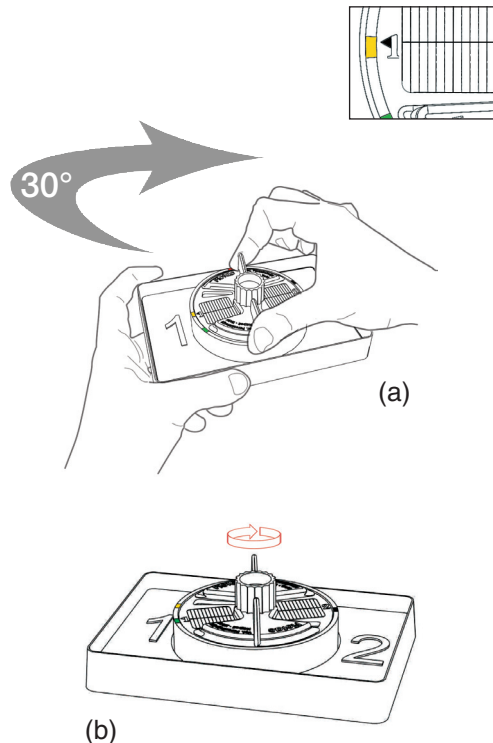

The FLOTAC® apparatus is then centrifuged for 5 min at 1,000 rpm (about 120 g).

Centrifugation can take place in either a large volume centrifuge (a) or in a microtitre centrifuge (b).

The centrifugation causes the debris to sink to the bottom of the flotation chambers, and the parasitic elements to float to the top under the two ruled grids.

If (i) the two flotation chambers of the FLOTAC® are completely filled, (ii) there is not residual suspension over the filling holes and (iii) the **Centrifuge adaptors** are cleaned, the FLOTAC® are already balanced for centrifugation.

5 minutes  
1000 rpm  
(~ 120 g)

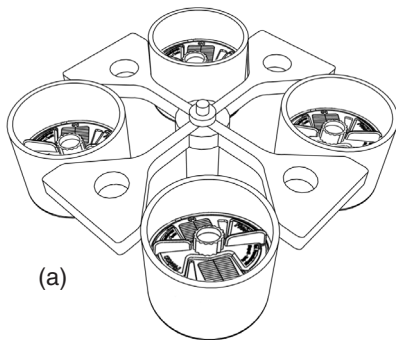
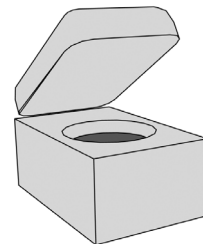

(a)

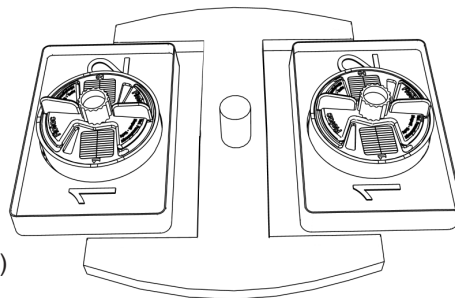

(b)

After centrifugation, the **Screw** is loosened, and the **Key** is used to turn the discs clockwise until the **Arrow** is aligned with the number 3 on the **Base** edge (red mark - READING)\*.

Thus, the top parts of the two floated suspensions (i.e. the parts which contain the parasitic elements) have been translated 90° and are now completely separated from the rest of the flotation chambers (i.e. the parts which contain the faecal debris).

In this step the **Reading disc** trails also the **Translation disc**.

**Turn firmly with one movement! Do not force further on n. 3 (red mark), otherwise the stop mechanism may be damaged!**

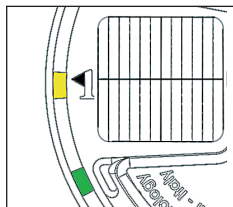
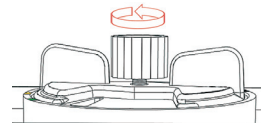
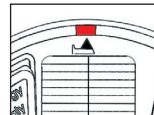

before

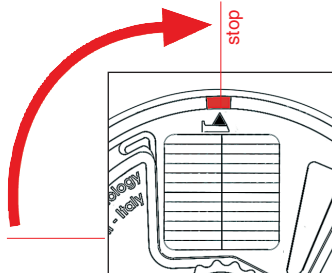

after

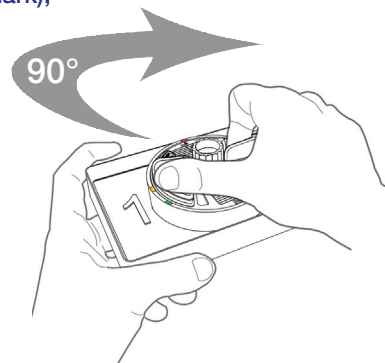

\* It is advisable to add some drops of the flotation solution(s) used into the two triangular filling holes before translation.

Turn the **Screw** counter-clockwise until it turns freely (a).

Remove the **Screw** and the **Key**.

Attach the **Microscope adaptor** to the microscope, and place the FLOTAC® apparatus on the **Microscope adaptor** with the ruled grid n.1 on the left (b).

If the **Microscope adaptor** is inconsistent with the microscope translation table, the FLOTAC® can be placed over a microscope slide on the microscope translation table.

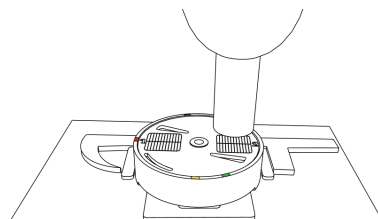
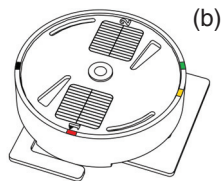
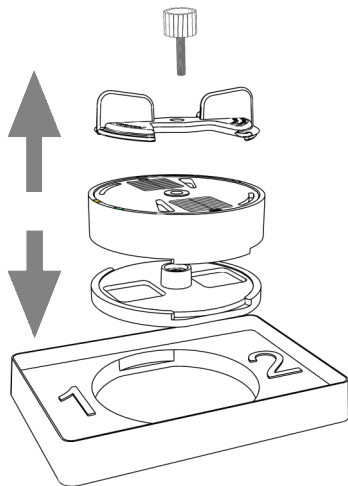
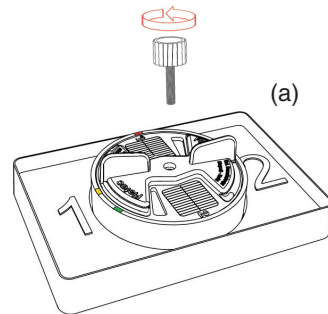



After the reading, remove the FLOTAC® apparatus from the **Microscope adaptor** and place it again on the **Bottom**, in the **Centrifuge adaptor** with the arrow pointing away from the technician. The **Key** is used to turn the discs counter-clockwise.

The FLOTAC® can be emptied in two positions:

(a) the **Arrow** is aligned with the n.1 (green mark = FILLING; turning the discs counter-clockwise, about 110°)

(b) the **Arrow** is aligned with the n.4 (black mark = OPEN; turning the discs counter-clockwise, about 300°).

(c) In these positions, the flotation chambers are opened; insert a pipette in the filling holes and aspirate the suspension. The use of an aspirator with a picker is advisable.

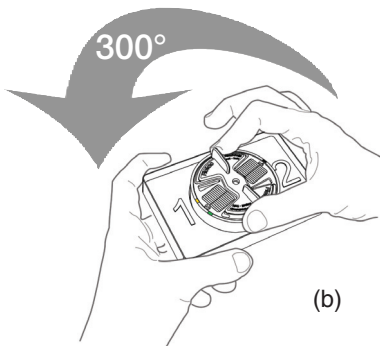
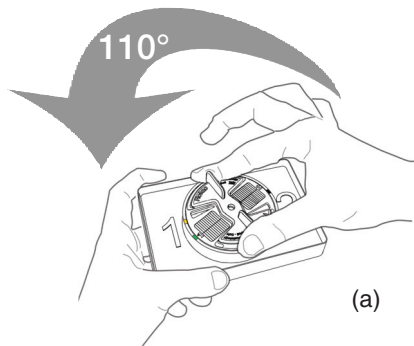
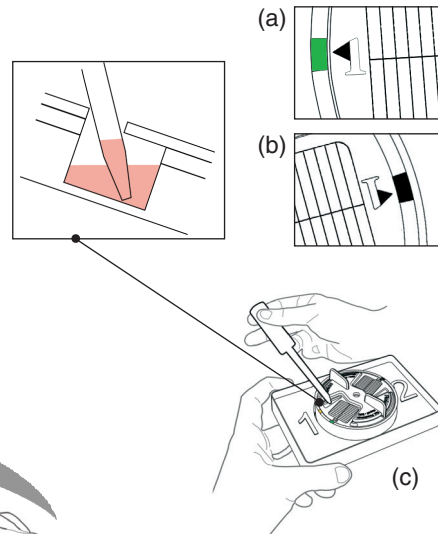

(a) The **Reading disc** is slightly elevated above the **Base** near the n.1 on the **Base** edge (green mark) and is ready to be removed using the edge of the **Key** as a lever (b).

After removing the **Reading disc**, the **Translation disc** can easily be removed by hand.

The FLOTAC® components and the FLOTAC® accessories can be washed in cold and hot water. All kinds of laboratory soaps can be used.

The FLOTAC® apparatus can be sterilized by using sodium hypochlorite (1 - 4%).

Important: do not boil and do not sterilize in an autoclave the FLOTAC® components or accessories.

Mild anti-calcareous solutions can be used in order to remove calcareous deposits caused by the cleaning with hard water.

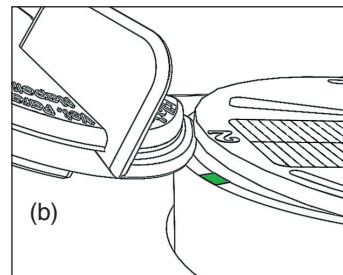
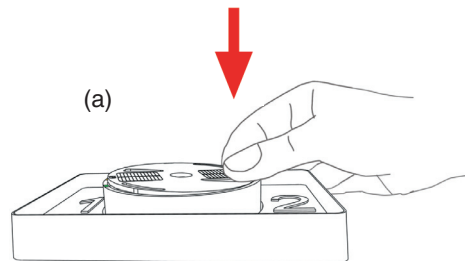
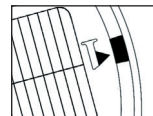

**2<sup>nd</sup> Part**

# **Flotac techniques**

## Introduction

Faecal egg count techniques are widely used for the study and diagnosis of parasites in humans and animals.

All coprological counting and/or estimating techniques give the number of parasitic elements (PE), such as eggs, larvae, oocysts and cysts, per gram of faeces (EPG, LPG, OPG, and CPG).

This second part of the Manual describes all the Flotac techniques, i.e., the Flotac basic technique, the Flotac dual technique, the Flotac double technique, the Flotac pellet techniques, and the Flotac faecal egg count calibration.

The FLOTAC<sup>®</sup> has been developed to easily carry out the flotation of the sample in a centrifuge, the translation of the apical portion of the floating suspension, and the subsequent examination under the microscope.

As described in the 1<sup>st</sup> part of this Manual, the FLOTAC<sup>®</sup> is a cylindrical-shaped instrument composed of three physical components: the **Base**, the **Translation disc** and the **Reading disc**. These components form the two **flotation chambers** which are designed for the optimal examination of 5 ml of faecal suspension in each flotation chamber (total volume = 10 ml).

There are two versions of the **Reading disc**: (a) **Reading disc 100X**, which permits a maximum magnification of 100X; and (b) **Reading disc 400X**, which permits a maximum magnification of 400X. The only difference between the two discs is the fineness of the ruled grids: the **Reading disc 400X** has a finer ruled grid than the **Reading disc 100X**.

There are two versions of the **Base**: (a) **Base 100X**, which is used together with the **Reading disc 100X**; and (b) **Base 400X**, which is used together with the **Reading disc 400X**. The only difference between the two Bases is the thickness of the bottom of the flotation chambers: the **Base 400X** has a thicker bottom than the **Base 100X**.

## FLOTAC 100

When FLOTAC® is assembled with the **Reading disc 100X** and with the **Base 100X** it is referred to as **FLOTAC 100**.

It has two flotation chambers which are 5 ml each  
 - **total volume = 10 ml**

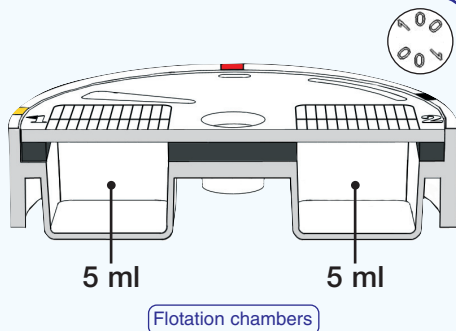

## FLOTAC 400

When FLOTAC® is assembled with the **Reading disc 400X** and with the **Base 400X** it is referred to as **FLOTAC 400**.

It has two flotation chambers which are 5 ml each  
 - **total volume = 10 ml**

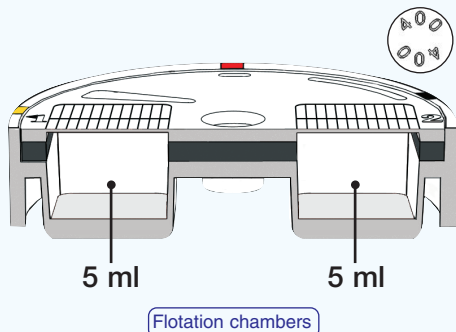

The **Translation disc** and the FLOTAC® accessories can be used both with **FLOTAC 100** and **FLOTAC 400**.

The FLOTAC<sup>®</sup> is a highly precise instrument based on original technical solutions, and made with high quality materials that guarantee consistent accurate performance.

**FLOTAC 400** is a recent improvement over **FLOTAC 100**. The use of **FLOTAC 100** however is suggested for the study of helminth eggs and larvae, and for teaching purposes because the **FLOTAC 100** has:

- (a) a more robust **Reading disc**;
- (b) flotation chambers that are easier to fill.

All the Flotac techniques can be used with either the **FLOTAC 100** or the **FLOTAC 400**.

When a faeces dilution of 1:10 is used with the Flotac basic technique, the readings of the two ruled grids (two flotation chambers = 1 gram of faeces) give rise to an analytic sensitivity of 1EPG, 1LPG, 1OPG, and 1CPG, i.e., **the international units of reference**.

The Flotation solutions (FS) have a fundamental role in determining the **analytic sensitivity**, i.e., the smallest amount of PE in a sample that can accurately be assessed by a technique, the **precision**, i.e., how well repeated observations agree with one another, and the **accuracy**, i.e., how well the observed value agrees with the true value, of all the copromicroscopic techniques (qualitative and/or quantitative) based upon flotation.

It should be noted that not all the FS used in parasitological labs can be utilized with the Flotac techniques. The final part of this Manual lists the 9 FS suggested for the optimal use of the Flotac techniques.

The most efficient FS for the most common PE eliminated with faeces from different herbivorous species are listed in different **Appendix: Flotation Solutions and Parasitic Elements** (in separate booklets).

Flotac techniques can be used for a wide range of PE. However, if one is interested in the diagnosis of a PE not listed in the above mentioned **Appendix**, or not cited in the scientific literature, the Flotac faecal egg count calibration is essential.

In this second part of the FLOTAC<sup>®</sup> Manual, we present the [faecal sampling](#) and the [Flotac techniques](#), specifically:

[Flotac basic technique](#)

[Flotac dual technique](#)

[Flotac double technique](#)

[Flotac faecal egg count calibration](#)

Each technique is summarized on two pages; the first page describes the operating steps of the technique, and the second page shows a scheme of the steps.

## Collection and preservation of faecal samples

The accuracy of any copromicroscopic technique (in terms of how well the observed values agree with the true values) greatly depends on the use of correct modes of faecal sampling and preservation. Whenever possible, it is important to observe the following instructions.

Faecal material should be collected as fresh (rectal or only just excreted faecal samples, if possible) and without contaminants (e.g. free-living soil nematodes, fly larvae, mites, etc.)

The total amount of faecal material (TFM) from which samples are taken should, if possible, be the total amount of faeces eliminated within a 24 hour period, in particular for young animals (calves/foals/lambs/kids).

### Sheep - Goats

Procure disposable gloves and collect faecal samples (as much as possible) directly from rectum. Alternatively (in particular for young animals), collect faecal samples (as much as possible) on a dry, clean floor.

Turn the gloves inside out, tie in knots, label with the animal ID, date, etc.

For routine shipment to the laboratory, samples can be cooled to 4°C and then packed with ice or other coolant (blu ice) for shipment via any of the 24- to 48-hour transport service.

Once at laboratory, the faecal sample is thoroughly homogenized and 5-10 grams of these faeces (depending on herbivorous species) are sampled and used for the chosen Flotac technique.



# FAECAL SAMPLING

## Cattle - Buffaloes - Horses

Procure disposable gloves and collect faecal samples (as much as possible) directly from rectum. Alternatively (in particular for young animals), collect faecal samples (as much as possible) on a dry, clean floor.

Turn the gloves inside out, tie in knots, label with the animal ID, date, etc.

For routine shipment to the laboratory, samples can be cooled to 4°C and then packed with ice or other coolant (blu ice) for shipment via any of the 24- to 48-hour transport service.

Once at laboratory, the faecal sample is thoroughly homogenized and 5-10 grams of these faeces (depending on ruminant species) are sampled and used for the chosen Flotac technique.

In herbivorous, the Flotac techniques can be performed on fresh (or stored at 4°C for 1-3 days) faecal samples and/or preserved (fixed) faecal samples. Do not freeze!!

Faecal samples should be preserved as follows: 1 part of faeces and 3 parts of fixative (formalin 5%, formalin 10% or SAF). It is important to note that complete homogenization of faeces and fixative is required. In addition, faecal samples should be homogenized in the fixative as soon as they are put into the containers.

## Sample homogenization in “liquid phase”

Particular care should be given to the homogenization of the total faecal material (TFM) before sample collection and weighing.

Since parasitic elements (PE) are not evenly distributed in faeces, an optimal homogenization of the TFM is better guaranteed if performed in a **liquid phase**:

- 1 - place the TFM collected (preferably faeces eliminated within a 24 hour period) in a suitable cleaned container (preferably disposable and biodegradable), weigh and add an equal amount of liquid (tap water), and

homogenize the suspension thoroughly using a spatula.

[If a scale is not available, the following alternative procedure can be used:

- a) - procure a graduated container;
- b) - transfer the TFM and add a known volume of tap water: in any case, less than the estimated volume of the TFM;
- c) - homogenize the suspension and measure the total volume;
- d) - calculate the volume of the TFM by subtracting the volume of the tap water added from the total volume;
- e) - add water until a final dilution ratio of 1:2 is reached (1 volume of TFM + 1 volume of tap water) and homogenize thoroughly].

2 - place 20 ml (= 10 grams of faecal sample), or a multiple, in a suitable container.

In order to fix, add 2 parts of fixative (final dilution ratio 1:4 = 1 part of faeces + 3 parts of water and fixative). In this circumstance, the concentration of the fixative should be increased by 1/3 (e.g., if the fixative used is "formalin 5%", the solution of formalin should be brought to 6.7%).

Homogenization of the sample in liquid phase is strongly suggested for research and/or diagnosis on faeces taken from large and medium sized dogs, and in the case of low or very low quantities of PE in the faeces.

It is important to note that the fixative used can markedly influence the sensitivity, precision and accuracy of any copromicroscopic technique based on either flotation or sedimentation.

Regarding the Flotac techniques, formalin 5%, formalin 10% and SAF\* give the best results in terms of sensitivity, precision and accuracy.

# THE BASIC STEPS OF THE FLOTAC TECHNIQUES

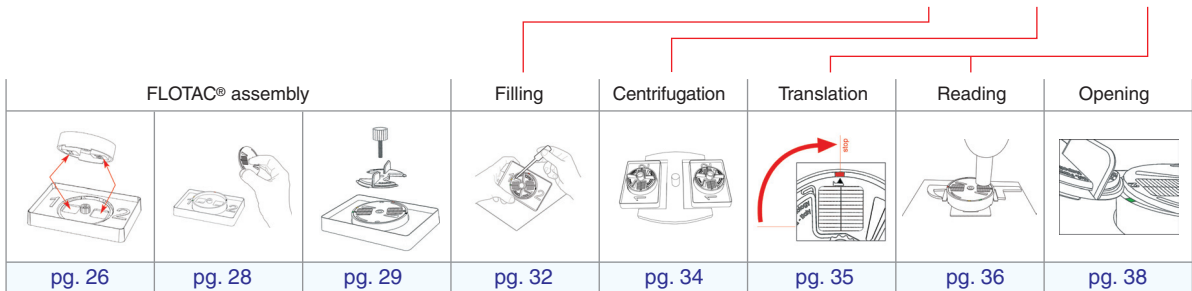
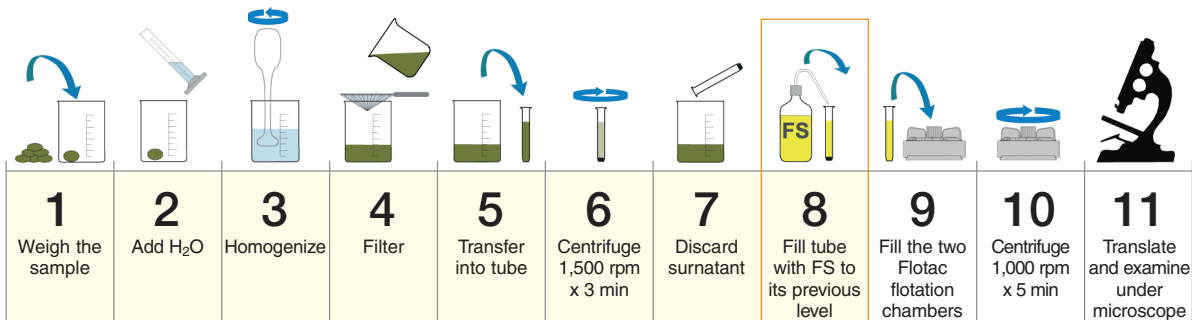

FLOTAC<sup>®</sup> Manual 1<sup>st</sup> part

The Flotac techniques are new multivalent, highly sensitive and accurate quantitative copromicroscopic techniques which utilize the FLOTAC<sup>®</sup>

## Flotac basic technique

The Flotac basic technique uses, during the performance of the technique, **one flotation solution (FS)**. This technique is especially suggested for the study and/or diagnosis of faecal samples containing a low or very low number of parasitic elements (PE) from a single parasitic species (natural or experimental mono-infection), or from faecal samples containing a low or very low number of various types of PE which all have the same behaviour with respect to the FS used.

The analytic sensitivity of the Flotac basic technique is: 1EPG, 1LPG, 1OPG, and 1CPG.

EPG, LPG, OPG, CPG = eggs, larvae, oocysts, and cysts per gram of faeces.

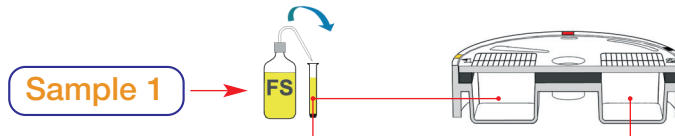
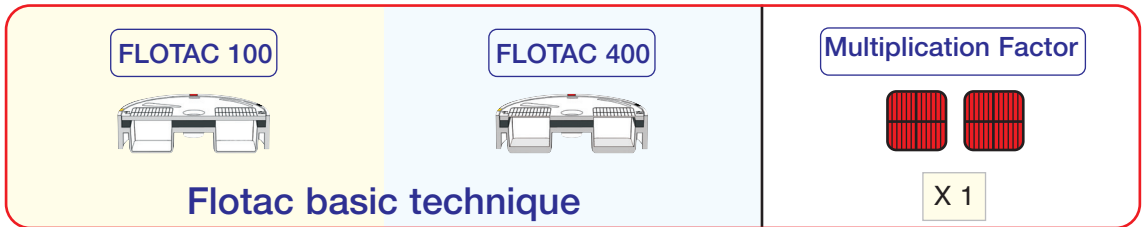

# FLOTAC BASIC TECHNIQUE

- 1 - Weigh 10 grams of fresh faeces taken from a larger amount of faecal material and thoroughly homogenize (preferably in liquid phase). When working with fixed samples use formalin 5% or formalin 10% or SAF at a dilution ratio of 1:4 (formalin 5% is suggested).
- 2 - Add 90 ml of tap water (dilution ratio = 1:10).  
**If less than 10 grams of faeces are available, use the final dilution ratio 1:10.**  
If the faecal sample is fixed, use the final dilution ratio 1:10 (1 part of faeces + 9 parts of water and fixative).
- 3 - Homogenize the suspension thoroughly (a house-hold mixer is suggested).
- 4 - Filter the suspension through a wire mesh (aperture = 250 µm).
- 5 - Place 11 ml of the filtered suspension into a conic tube. The two flotation chambers of the FLOTAC® require 5 ml each (total volume 10 ml = 1 gram of faeces); 1 ml more is necessary in order to easily fill the two flotation chambers.
- 6 - Centrifuge the tube for 3 min at 1,500 rpm (about 170 g).
- 7 - After centrifugation, discard the supernatant, leaving only the sediment (pellet) in the tube.
- 8 - Fill the tube with the chosen flotation solution (**FS**) to the previous 11 ml level.
- 9 - Homogenize the suspension and fill the two flotation chambers of the FLOTAC®.
- 10 - Close the FLOTAC® and centrifuge for 5 min at 1,000 rpm (about 120 g).
- 11 - After centrifugation, translate the top parts of the flotation chambers and read under the microscope.

The analytic sensitivity of the Flotac basic technique is: 1EPG, 1LPG, 1OPG, and 1CPG.

For the FLOTAC® steps 9 - 11 see **FLOTAC® Manual 1<sup>st</sup> part** pgs. 32 - 36

For **FS** see pg. 75 and **Appendix**

# FLOTAC BASIC TECHNIQUE

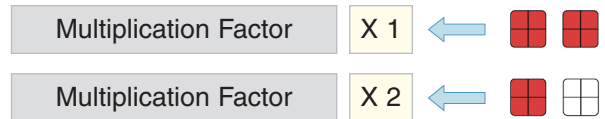
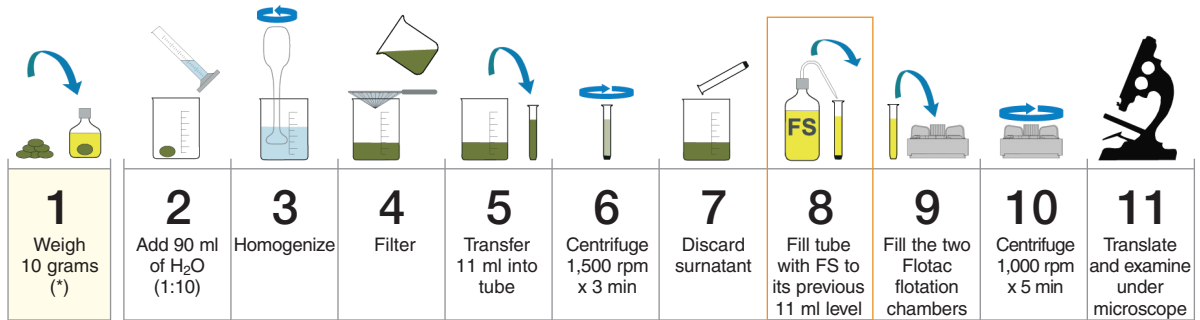

(\*) If necessary fix 1:4

See [FS](#) pg. 75 and [Appendix](#)

## Flotac dual technique

The Flotac dual technique is based upon the use, during the performance of the technique, of **two flotation solutions** that have complementary specific densities (or efficiencies), and are used in parallel on the same faecal sample. This technique is especially suggested for diagnostic purposes or epidemiological surveys in order to perform a wide parasitological screening of different parasitic elements in a single faecal sample.

The analytic sensitivity of the Flotac dual technique is: 2EPG, 2LPG, 2OPG, and 2CPG.

EPG, LPG, OPG, CPG = eggs, larvae, oocysts, and cysts per gram of faeces.

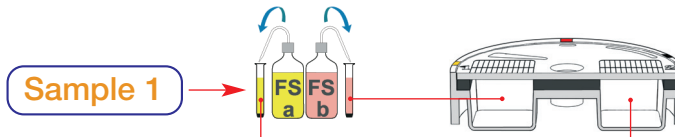
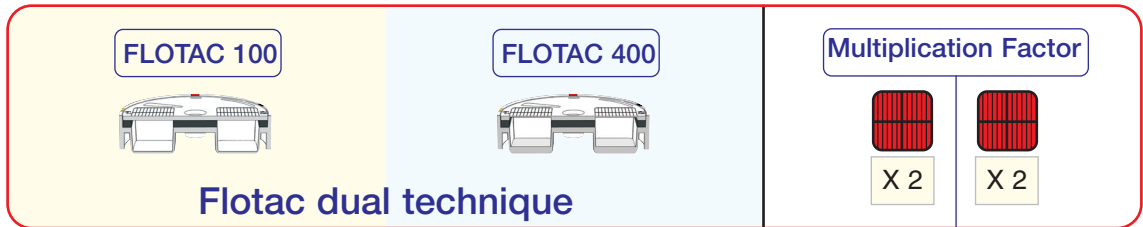

# FLOTAC DUAL TECHNIQUE

- 1 - Weigh 10 grams of fresh faeces taken from a larger amount of faecal material and thoroughly homogenize (preferably in liquid phase). When working with fixed samples use formalin 5% or formalin 10% or SAF at a dilution ratio of 1:4 (formalin 5% is suggested).
- 2 - Add 90 ml of tap water (dilution ratio = 1:10).  
**If less than 10 grams of faeces are available, use the final dilution ratio 1:10.**  
If the faecal sample is fixed, use the final dilution ratio 1:10 (1 part of faeces + 9 parts of water and fixative).
- 3 - Homogenize the suspension thoroughly (a house-hold mixer is suggested).
- 4 - Filter the suspension through a wire mesh (aperture = 250 µm).
- 5 - Place 2 aliquots, 6 ml each, of the filtered suspension into two conic tubes. The two flotation chambers of the FLOTAC® require 5 ml (= 0.5 grams of faeces) each; 1 ml more is necessary in order to easily fill each flotation chamber.
- 6 - Centrifuge the two tubes for 3 min at 1,500 rpm (about 170 g).
- 7 - After centrifugation, discard the supernatant, leaving only the sediments (pellets) in the tubes.
- 8 - Fill the two tubes with two different flotation solutions (**FS**), **FSa** and **FSb**, to the previous 6 ml level.
- 9 - Thoroughly homogenize the suspensions and fill the two flotation chambers of the FLOTAC® with the two suspensions: chamber 1 with suspension in **FSa**, and chamber 2 with suspension in **FSb**.
- 10 - Close the FLOTAC® and centrifuge for 5 min at 1,000 rpm (about 120 g).
- 11 - After centrifugation, translate the top parts of the flotation chambers and read under the microscope.

With the Flotac dual technique, the reference unit is the single flotation chamber (volume 5 ml = 0.5 grams of faeces).

**The analytic sensitivity of the Flotac dual technique is: 2EPG, 2LPG, 2OPG, and 2CPG.**

For the FLOTAC® steps 9 - 11 see **FLOTAC® Manual 1<sup>st</sup> part** pgs. 32 - 36

For **FS** see pg. 75 and **Appendix**



# FLOTAC DUAL TECHNIQUE

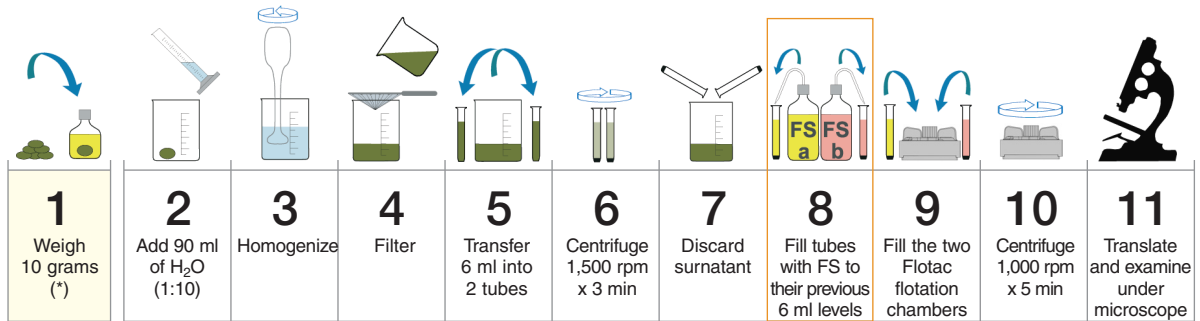

(\*) If necessary fix 1:4

 See **FS** pg. 75 and **Appendix**

Multiplication Factor

X 2



## Flotac double technique

The Flotac double technique is based on the simultaneous examination of **two different faecal samples from two different hosts** using the same FLOTAC<sup>®</sup> apparatus. With this technique, the two faecal samples are each assigned to its own single flotation chamber, using the same flotation solution.

The analytic sensitivity of the Flotac double technique is: 2EPG, 2LPG, 2OPG, and 2CPG.

EPG, LPG, OPG, CPG = eggs, larvae, oocysts, and cysts per gram of faeces.

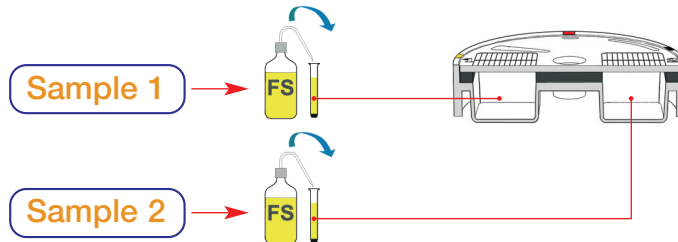
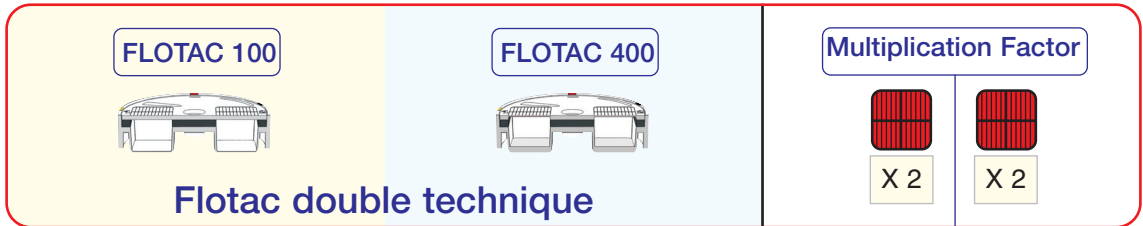

# FLOTAC DOUBLE TECHNIQUE

The steps n. 1 to n. 8 are performed on two different faecal samples.

- 1 - Weigh 10 grams of fresh faeces taken from a larger amount of faecal material (preferably in liquid phase). When working with fixed samples use formalin 5% or formalin 10% or SAF at a dilution ratio of 1:4 (formalin 5% is suggested).
- 2 - Add 90 ml of tap water (dilution ratio = 1:10).  
**If less than 10 grams of faeces are available, use the final dilution ratio 1:10.**  
If the faecal sample is fixed, use the final dilution ratio 1:10 (1 part of faeces + 9 parts of water and fixative).
- 3 - Homogenize the suspension thoroughly (a house-hold mixer is suggested).
- 4 - Filter the suspension through a wire mesh (aperture = 250 µm).
- 5 - Place 6 ml of the filtered suspension into a conic tube.
- 6 - Centrifuge the tube for 3 min at 1,500 rpm (about 170 g).
- 7 - After centrifugation, discard the supernatant, leaving only the sediment (pellet) in the tube.
- 8 - Fill the tube with the chosen flotation solution (**FS**) to the previous 6 ml level.

9 - Fill the two flotation chambers of the FLOTAC®: **flotation chamber n. 1** with the first sample; **flotation chamber n. 2** with the second sample.

10 - Close the FLOTAC® and centrifuge for 5 min at 1,000 rpm (about 120 g).

11 - After centrifugation, translate the top parts of the flotation chambers and read under the microscope.

With the Flotac double technique, the reference unit is the single flotation chamber (volume 5 ml = 0.5 grams of faeces).

**The analytic sensitivity of the Flotac double technique is: 2EPG, 2LPG, 2OPG, and 2CPG.**

For the FLOTAC® steps 9 - 11 see **FLOTAC® Manual 1<sup>st</sup> part** pgs. 32 - 36

For **FS** see pg. 75 and **Appendix**

# FLOTAC DOUBLE TECHNIQUE

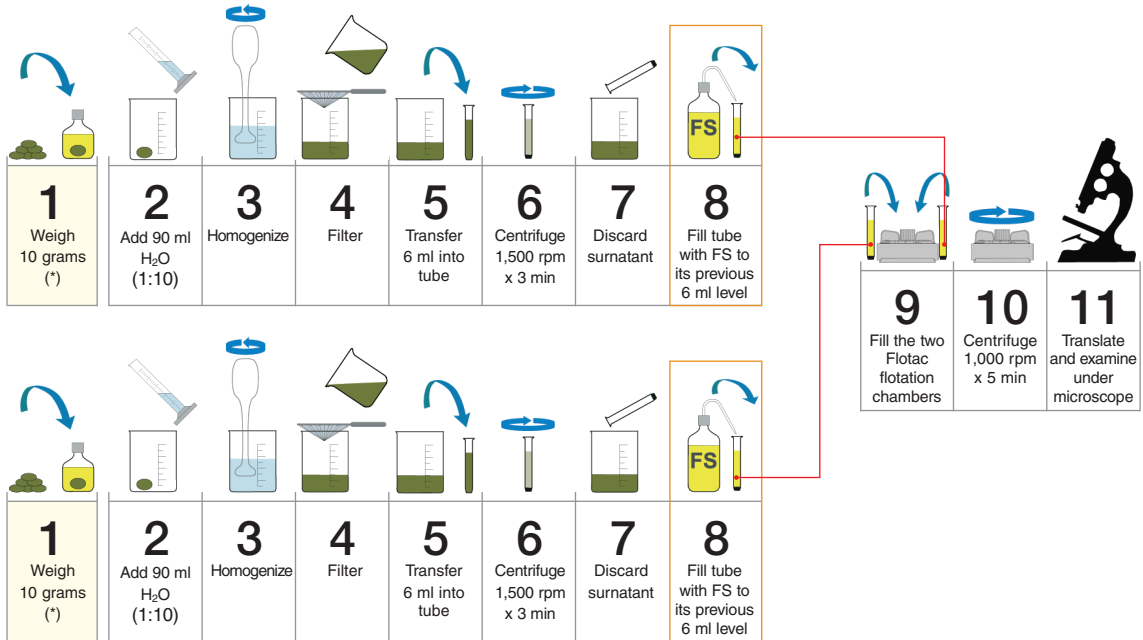

(\*) If necessary fix 1:4

   See FS pg. 75 and [Appendix](#)

Multiplication Factor

X 2



# Procedures for preparing faeces rich in fats for the Flotac techniques

Whenever faecal samples are rich in fats (e.g., faecal samples from lactating calves/foals/lambs/kids), it is advisable to prepare the pellet with ether or ethyl acetate after step n. 7 of all the Flotac techniques.

## Procedures for preparing faeces rich in fats for the Flotac techniques

If faecal samples are rich in fats (e.g., faecal samples from lactating calves/foals/lambs/kids), after step n. 7 of all the Flotac techniques, use ether (E) or ethyl acetate (EA) as a lipid removing agent, as follows:

**7a** - Add 10 ml of physiological saline (SAL) and either 2 ml of E – C<sub>2</sub>H<sub>5</sub>(2O) – or EA (or alternatively, 7 ml of SAL + 3 ml of E/EA) to the pellet; stir vigorously for 30 - 60 sec if by hand, or at least 15 sec if on vortex.

**7b** - Centrifuge at 1,500 rpm for 3 min. Three layers should result: the sediment layer containing the parasitic elements (PE); a layer of fats in the middle; and a layer of E/EA at the top.

**7c** - Discard the surnatant leaving only the pellet in the tube and clean the edges of the tube using cotton to remove the fat residues.

Continue with the other steps of the chosen Flotac technique.

### Optional:

if it is necessary to remove the E/EA residual from the pellet, wash it with water or SAL as follows:

**7d** - Add tap water or SAL to reach a final volume of 15 ml.

**7e** - Homogenize the suspension thoroughly.

**7f** - Centrifuge at 1,500 rpm for 3 min.

**7g** - Discard the surnatant.

Note - This procedure is recommended only in the case of faecal samples that are very rich in fats. The use of E, and even more so, of EA, may damage some types of PE (e.g., Hookworm eggs, etc.).

In addition, the repeated use of E and/or EA may damage the FLOTAC® discs.

(a) or 7 ml of SAL + 3 ml of E/EA

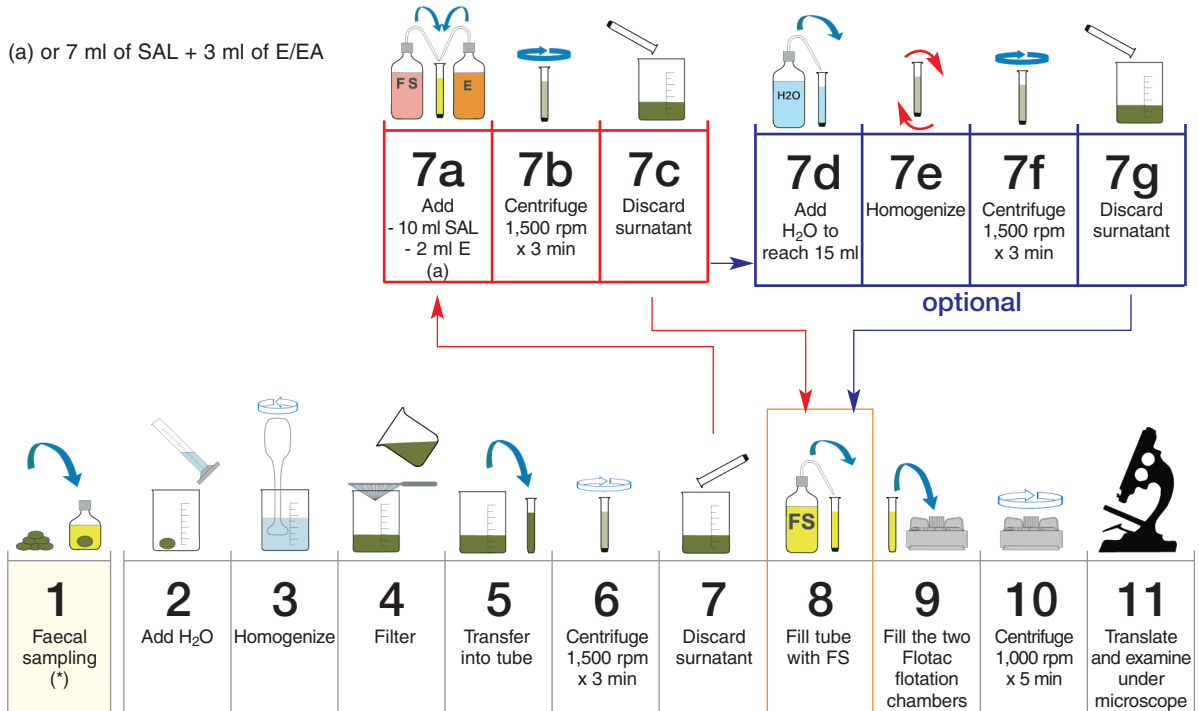

(\*) If necessary fix 1:4

See FS pg. 75 and [Appendix](#)





## Faecal sample dilution

With regard to all the Flotac techniques, the number of Parasitic elements (PE = eggs, larvae, oocysts, and cysts) under examination can effect the accuracy of the count. In particular, count results are accurate when the number of PE is under 500 PE per gram of faeces (PEG), i.e., PE = 250 per ruled grid.

When PEG levels are greater than 500 (a situation occurring especially for sheep and goats), it is advisable to dilute the sample suspension at step n. 2 of each Flotac technique, as specified in the table on the opposite page (pg. 65).



# FAECAL SAMPLE DILUTION

Range of number of parasitic elements per gram of faeces	FLOTAC 100	FLOTAC 400	Reading area and multiplication factor		
					
	Dilution ratio of faecal sample at step 2 of each Flotac technique				
1 - 500		1 : 10	x 1	x 2	ns
500 - 1000		1 : 20	x 2	x 4	ns
1000 - 1500		1 : 30	x 3	x 6	ns
1500 - 2000		1 : 40	x 4	x 8	ns
2000 - 3000		1 : 50	x 5	x 10	x 20
> 3000		1 : 100	ns	ns	x 40

ns = not suggested

## Flotac faecal egg count calibration

FLOTAC 100



FLOTAC 400



Multiplication Factor



X 2

Flotac faecal egg count calibration

# FLOTAC FAECAL EGG COUNT CALIBRATION

## Flotac faecal egg count calibration (FFECC) and choice of the flotation solutions

Flotation solutions (**FS**) play a key role in determining the sensitivity, precision and accuracy of any copromicroscopic technique (qualitative and/or quantitative) based upon flotation.

Usually, in the manuals of diagnostic parasitology or in the scientific literature, only the specific gravity (s.g.) and/or density is reported for **FS**. It is commonly believed that the efficiency of a **FS** in terms of the capacity to float parasitic elements (PE = eggs, larvae, oocysts and cysts) increases as the s.g. of the **FS** increases. However, PEs are not “inert elements”! The interactions between the elements within a **floating faecal suspension** (**FS** components, PE, fixative, and residues of the host alimentations) are still unknown. However, it should be noted that:

- 1) As a rule, diverse **FS** with the same s.g., do not produce the same results with respect to the same PE, even when the same technique is used.
- 2) Usually, a given **FS** which is very efficient with respect to a given PE, using a given technique, does not produce the same results if the technique is changed.
- 3) Usually, a given **FS** which is very efficient with respect to a given PE, using a given technique, in a sample examined as fresh, does not produce the same results if the method of faeces preservation changes (e.g., frozen, fixed in formalin or in other fixatives).
- 4) It may happen that a given **FS** which is very efficient with respect to a given PE, using a given technique, does not produce the same results if the diet of the host changes.

As a result, when a copromicroscopic technique based upon flotation is used, each PE must be considered independently with respect to (a) the **FS**, (b) the technique, and (c) the method of faeces preservation used.

What is known for a given PE cannot be used either for a “similar” PE, or for the same PE when the technique or the faecal preservation method changes.

# FLOTAC FAECAL EGG COUNT CALIBRATION

Flotac techniques augment the efficiency of the various **FS** with respect to clarity of reading, sensitivity, flotation of high numbers of PE, precision and accuracy; but they also augment the negative aspects of some **FS** (turbidity of reading, floating of small and large faecal debris, etc.). As a consequence, not all the **FS** used in parasitological labs can be used with the Flotac techniques.

The section **Flotation Solutions** of this Manual (pg. 75) reports the chemical composition of the 9 **FS** (chosen from the 14 **FS** listed in the paper by Cringoli et al., Vet Parasitol 2004, 123: 121-131) that give the best results using the Flotac techniques with respect to the clarity of reading, sensitivity, precision and accuracy.

The most efficient **FS** for the most common PE eliminated with herbivorous faeces are shown in the schemes located in the **Appendix**.

In these schemes, the 9 **FS** are divided into 4 groups based upon their efficiency as determined by a series of FFECC performed on composite faecal samples from different herbivorous species.

The Flotac techniques can be used for a wide range of PE eliminated with faeces from different herbivorous species.

For dog PE not listed in the above mentioned Appendix or in scientific publications the FFECC is necessary.

The FFECC consists in a preliminary screening of the 9 **FS** on the PE of interest, carrying out at least 6 replicates, for each **FS**. A single flotation chamber of the FLOTAC 100 or FLOTAC 400 is utilized for each replicate (analytic sensitivity = 2 parasitic elements per gram of faeces). In addition, the method of faeces preservation should be considered.

# FLOTAC FAECAL EGG COUNT CALIBRATION

- 1 - Weigh 40 grams of faecal sample with the parasitic element of interest.  
If necessary, add the chosen fixative [formalin 5%, formalin 10%, SAF, etc.: 1 part of faecal sample + 3 parts of fixative (120 ml); final volume = 160 ml], homogenize thoroughly and leave the faeces and fixative in contact for the necessary period of time (12 - 24 hour period).
- 2 - Add 360 ml of tap water (dilution ratio = 1:10)  
(for fixed faeces as above described, add 240 ml of tap water; final dilution ratio 1:10)
- 3 - Homogenize the suspension thoroughly (a house-hold mixer is suggested).
- 4 - Filter the suspension through a wire mesh (aperture = 250 µm).
- 5 - Divide the suspension into 54 aliquots in order to have 6 replicates of each of the 9 flotation solutions (FS): each aliquot is 6 ml, and is placed into a 15 ml conic tube.
- 6 - Centrifuge the 54 tubes for 3 min at 1,500 rpm (about 170 g).
- 7 - After centrifugation, discard the supernatant, leaving only the sediments (pellets) in the tubes.
- 8 - Randomly assign each of the 9 groups of 6 tubes containing a pellet to a different FS; i.e., 6 replicates for each FS.
- 9 - For each replicate, add the chosen FS to the tube (to reach 6 ml) and fill one flotation chamber of the FLOTAC®.
- 10 - Close the FLOTAC® and centrifuge for 5 min at 1,000 rpm (about 120 g).
- 11 - After centrifugation, translate the top of the faecal suspension and read under the microscope.

The analytic sensitivity during FFECC is: 2EPG, 2LPG, 2OPG, and 2CPG.

For the FLOTAC® steps 9 - 11 see FLOTAC® Manual 1<sup>st</sup> part pgs. 32 - 36

For FS see pg. 75 and Appendix

# FLOTAC FAECAL EGG COUNT CALIBRATION

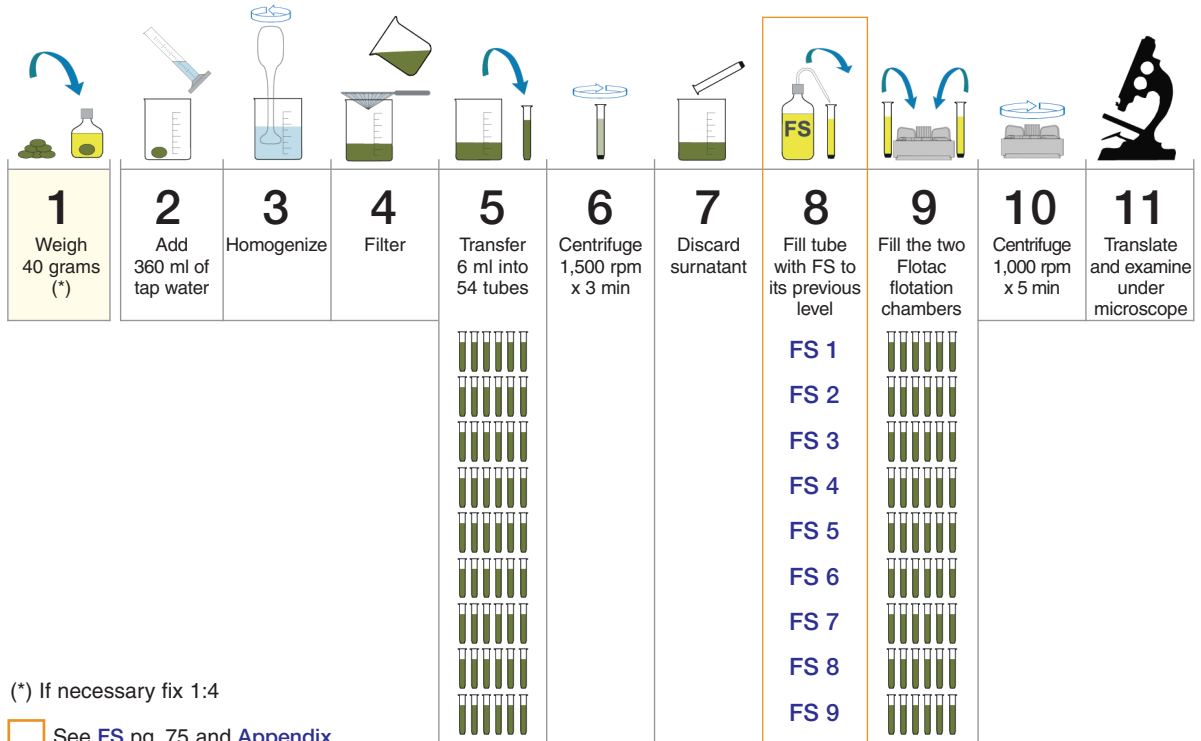

(\*) If necessary fix 1:4

 See [FS](#) pg. 75 and [Appendix](#)

# FLOTAC FAECAL EGG COUNT CALIBRATION

In order to evaluate the results of any FFECC, the first element to be considered is the clarity of reading produced by a given FS. Indeed, the FS which produce the flotation of a large amount of either small or large debris must be excluded.

The technical parameters which should be considered in the evaluation of each FS are:

- 1) The mean number (derived from 6 replicates) of parasitic elements per gram of faeces (PEG).
- 2) The coefficient of variation [ $CV = (\text{standard deviation} / \text{mean PEG}) \times 100$ ]. CV values indicate the precision (how well repeated observations agree with one another) of the technique, when utilizing a given FS for a specific PE. The lower the CV, the more precise is the technique; values of CV below 5% should be considered as optimal.

Comparative evaluation of the FS is made using the following steps:

- a) Compare the mean values of PEG produced by different FS and organize the values into statistically homogeneous groups. The FS producing the highest PEG values should be included in the first choice group - the gold standard - (blue); they are followed by the FS of second choice (green), third choice (yellow), fourth choice (white), which progressively produce lower PEG values.
- b) Within each group, for each FS, mark the CV range with a letter: (A) CV below 5%; (B) CV between 5% and 10%; (C) CV between 10% and 15%; (D) CV between 15% and 20%; and (E) CV above 20% (see schemes in [Appendix](#)).

During the FFECC it is important to consider the following critical steps of the technique:

# FLOTAC FAECAL EGG COUNT CALIBRATION

**Step n. 5** - This is a delicate step, because it is advisable to have the same number of PE in each tube (replicate). Thus, it is very important to thoroughly homogenize the faecal suspension before filling the tubes. Magnetic stirrers should be avoided; even though they are very useful for preparing solutions, they should not be used for homogenizing suspensions.

Best results are obtained with two technicians working together: one technician transfers the suspension into two containers over and over again (avoid foam formation); the second technician aspirates the required amount of faecal suspension (6 ml) using a calibrated pipette.

**Step n. 9** - Fill the two flotation chambers quickly, and then quickly close the FLOTAC®.

**Summarizing:** after the FFECC is performed, the **FS** in the first choice group are the most efficient (producing the highest mean PEG values), the most precise (producing the lowest CV values), and give the best clarity of reading.

The first choice **FS** are especially recommended for research and/or diagnosis (with Flotac basic technique and/or Flotac double technique) when the faecal samples contain PE from a single parasitic species (natural or experimental mono-infection), or when the faecal samples contain different PE that have the same behaviour with respect to the **FS** used.

The second choice **FS** and/or the subsequent choice **FS** are useful for research and/or diagnoses which utilize the Flotac dual technique (using the **FS** in parallel with the first choice and/or other choice **FS**) to perform a wide parasitological screening of different PE.

The modern concept of **quality with respect to parasitological diagnosis** and of **standardization of copromicroscopic techniques based upon flotation** requires that the “**Calibration of FS**” should always be performed regardless of the technique utilized (e.g., McMaster technique, etc.), and should always be performed for each method of faecal preservation used.



# Flotation Solutions

Flotation solutions play a key role in determining the sensitivity, precision and accuracy of any copromicroscopic technique (qualitative and/or quantitative) based upon flotation.

Among the 14 flotation solutions listed in the paper by Cringoli et al. (Vet Parasitol 2004, 123: 121- 131), the following 9 flotation solutions give the best results with the Flotac techniques with respect to clarity of reading sensitivity, precision and accuracy.

# FLOTATION SOLUTIONS

Flotation solutions		Specific gravity (s.g.)
FS 1	Sheather's Sugar Solution	1.200
FS 2	Saturated Sodium Chloride	1.200
FS 3	Zinc Sulphate 1.200	1.200
FS 4	Sodium Nitrate	1.200
FS 5	Sucrose and Potassium Iodomercurate (Rinaldi)	1.250
FS 6	Magnesium Sulphate	1.280
FS 7	Zinc Sulphate 1.350	1.350
FS 8	Potassium Iodomercurate	1.440
FS 9	Zinc Sulphate and Potassium Iodomercurate (Tampieri - Restani)	1.450

## FS 1 - Sheather's Sugar Solution (s.g. - 1.200)

- 1 - Combine 355 ml of water and 454 grams of granulated sugar (sucrose). Corn syrup and dextrose are not suitable substitutes.
- 2 - Dissolve the sugar in the water by stirring on a magnetic stirrer over low or indirect heat (e.g., the top half of a double boiler). If the container is placed on a high direct heat source, the sugar may caramelize instead of dissolving in the water.
- 3 - After the sugar is dissolved and the solution has cooled to room temperature, add 6 ml of formaldehyde (40%) USP to prevent microbial growth.
- 4 - Check the s.g. with a hydrometer.

## FS 2 - Saturated Sodium Chloride (NaCl, s.g. - 1.200)

- 1 - Combine 1000 ml of warm water and about 500 grams of salt until no more salt goes into solution and the excess settles on the bottom of the container.
- 2 - Dissolve the salt in the water by stirring on a magnetic stirrer.
- 3 - To ensure that the solution is fully saturated, it should be allowed to stand overnight at room temperature. If the remaining salt crystals dissolve overnight, more can be added to ensure that the solution is saturated.
- 4 - Check the s.g. with a hydrometer, recognizing that the s.g. of saturated solution will vary slightly with environmental temperature.

## FS 3 - Zinc Sulphate (ZnSO<sub>4</sub>·7H<sub>2</sub>O, s.g. - 1.200)

- 1 - Combine 500 ml of water and 330 grams of zinc sulphate.
- 2 - Dissolve the zinc sulphate in the water by stirring on a magnetic stirrer.
- 3 - Add water to reach a final volume of 1000 ml.
- 4 - Check the s.g. with a hydrometer.

# FLOTATION SOLUTIONS

## FS 4 – Sodium Nitrate ( $\text{NaNO}_3$ , s.g. - 1.200)

- 1 - Combine 500 ml of water and 315 grams of sodium nitrate.
- 2 - Dissolve the sodium nitrate in the water by stirring on a magnetic stirrer.
- 3 - Add water to reach a final volume of 1000 ml.
- 4 - Check the s.g. with a hydrometer.

## FS 5 – Sucrose and Potassium Iodomercurate (Rinaldi) (s.g. 1.250)

- 1 - Combine 600 ml of water and 600 grams of sucrose.
- 2 - Dissolve the sugar in the water by stirring on a magnetic stirrer over low or indirect heat (e.g., the top half of a double boiler). If the container is placed on a high direct heat source, the sugar may caramelize instead of dissolving in the water.
- 3 - After the sugar is dissolved and the solution has cooled to room temperature, add 20 ml of solution B (see below).
- 4 - Check the s.g. with a hydrometer.

### Solution B

- 1 - Combine 100 grams of mercuric iodide and 63 ml of water.
- 2 - Stir vigorously.
- 3 - Add 78 grams of potassium iodide and stir again.

## FS 6 – Magnesium Sulphate ( $\text{MgSO}_4$ , s.g. - 1.280)

- 1 - Combine 500 ml of water and 350 grams of magnesium sulphate.
- 2 - Dissolve the magnesium sulphate in the water by stirring on a magnetic stirrer.
- 3 - Add water to reach a final volume of 1000 ml.
- 4 - Check the s.g. with a hydrometer.

## FS 7 – Zinc Sulphate ( $\text{ZnSO}_4\cdot 7\text{H}_2\text{O}$ , s.g. - 1.350)

- 1 - Combine 685 ml of water and 685 grams of zinc sulphate.
- 2 - Dissolve the zinc sulphate in the water by stirring on a magnetic stirrer.
- 3 - Check the s.g. with a hydrometer.

## FS 8 – Potassium Iodomercurate (s.g. - 1.440)

- 1 - Combine 399 ml of water and 150 grams of mercuric iodide.
- 2 - Stir vigorously.
- 3 - Add 111 grams of potassium iodide and stir again.
- 4 - Check the s.g. with a hydrometer.

## FS 9 – Zinc Sulphate and Potassium Iodomercurate (Tampieri - Restani) (s.g. - 1.450)

- 1 - Combine 600 ml of water and 600 grams of zinc sulphate ( $\text{ZnSO}_4\cdot 7\text{H}_2\text{O}$ ).
- 2 - Dissolve the zinc sulphate in the water by stirring on a magnetic stirrer.
- 3 - After the zinc sulphate is dissolved add the solution B (see below).
- 4 - Check the s.g. with a hydrometer.

### Solution B

- 1 - Combine 100 grams of mercuric iodide and 63 ml of water.
- 2 - Stir vigorously.
- 3 - Add 78 grams of potassium iodide and stir again.

